



METÁLICA
F O R M A S

FORMAS METÁLICAS



VIGA T PARA COBERTURA (FORMA SIMPLES E DUPLA)

NOSSA HISTÓRIA

Iniciamos nossa trajetória em 2016 na cidade de Corupá em Santa Catarina. O objetivo principal de seus sócios foi criar uma empresa inovadora, e que pudessem creditar a ela todas suas experiências profissionais de mais de trinta anos no setor metalúrgico.

Buscando seu posicionamento de mercado, a empresa investe constantemente em tecnologias de processos, e treinamento de seus colaboradores para entregar seus produtos com excelência.

NOSSA POLÍTICA DE QUALIDADE

Atender as expectativas de nossos clientes e fornecedores, com a entrega de produtos e serviços dentro dos padrões estabelecidos.

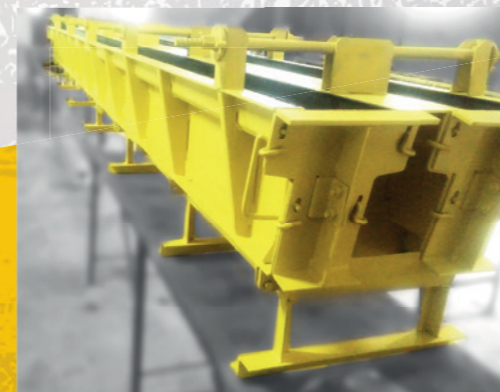
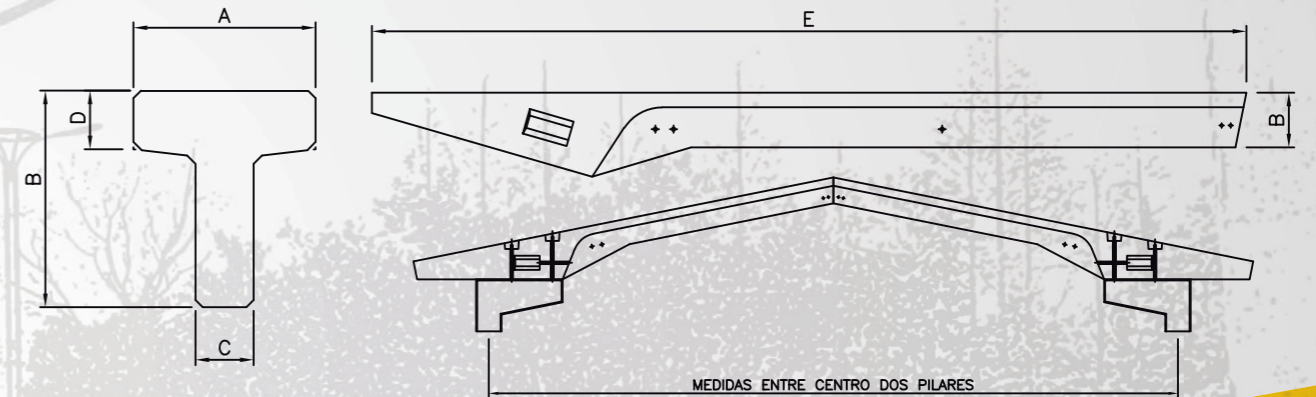
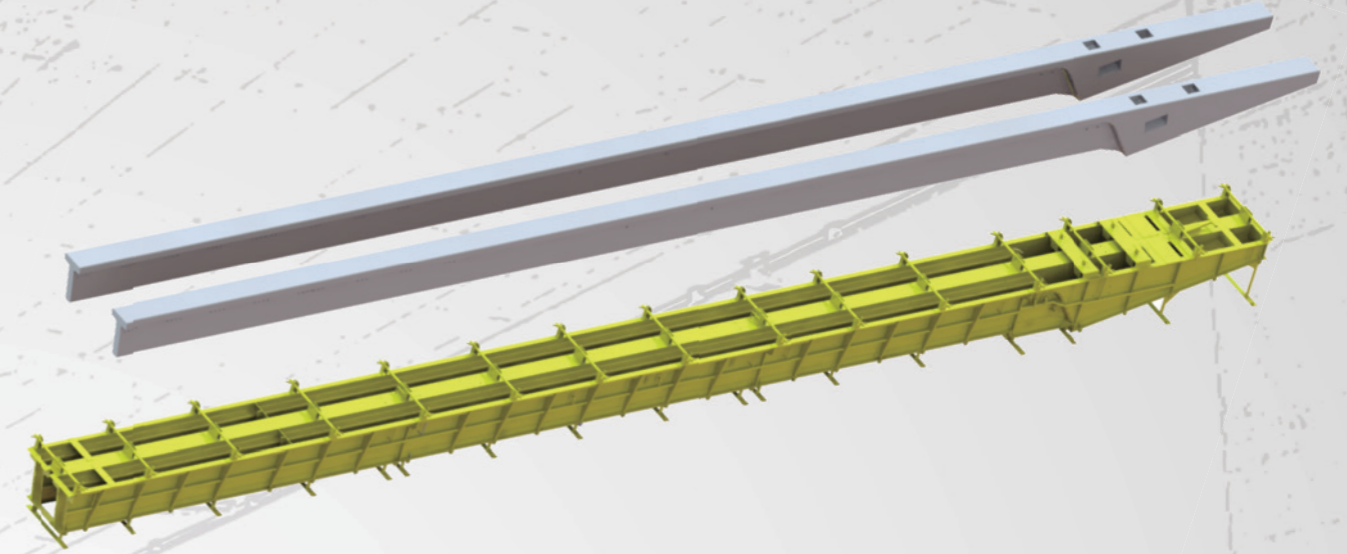

VÃO	A (MM)	B (MM)	C (MM)	D (MM)	E (MM)	VOLUME M³	PESO KG
30 M					17133	1,28	3136
29 M					16623	1,25	3062
28 M	300	600	100	100	16113	1,21	2964
27 M					15603	1,18	2891
26 M					15093	1,15	2817
25 M					13920	0,83	2033
24 M					13410	0,81	1984
23 M	250	500	80	80	12900	0,78	1911
22 M					12390	0,75	1837
21 M					11880	0,73	1788
20 M					11294	0,56	1372
19 M					10784	0,54	1323
18 M	250	400	80	80	10274	0,51	1249
17 M					9764	0,49	1200
16 M					11294	0,56	1372
15 M					10784	0,54	1323
14 M	250	300	80	80	10274	0,51	1249
13 M					9764	0,49	1200
12 M					7189	0,29	710
11 M					6679	0,27	661
10 M	200	250	80	80	6169	0,26	637
9 M					5659	0,24	588



METÁLICA
F O R M A S



PILAR (FORMA SIMPLES E DUPLA)

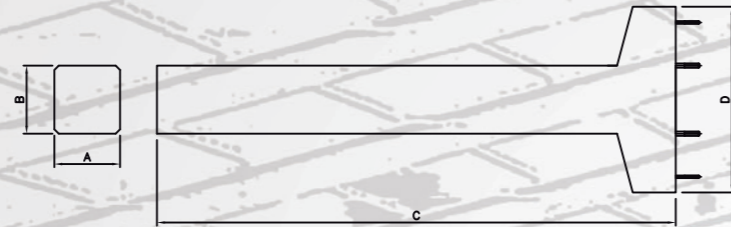
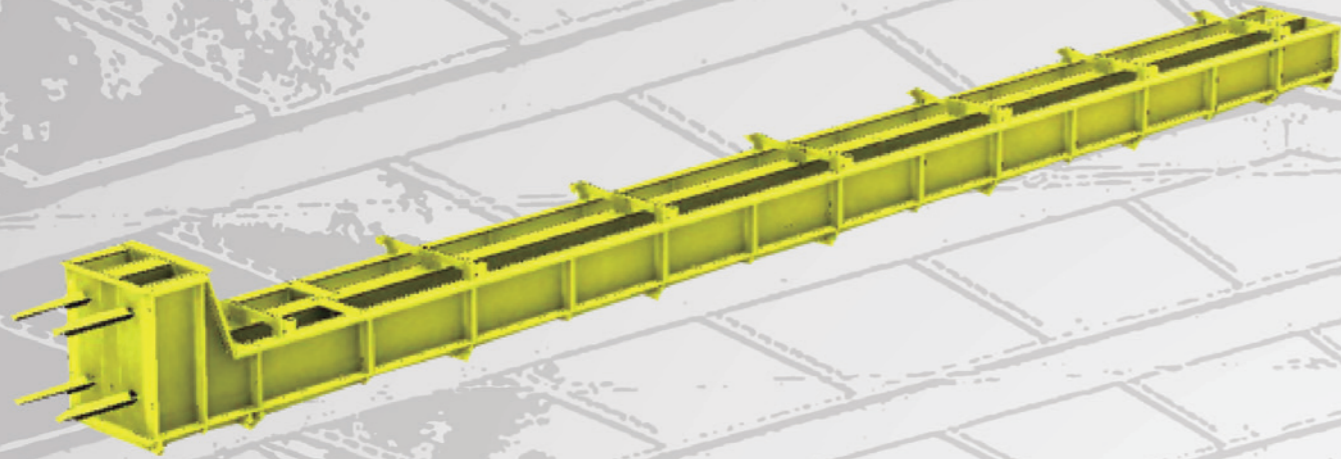

PILAR COM CABEÇA DUPLA PARAFUSO						
VÃO	A (MM)	B (MM)	C (MM)	D (MM)	VOLUME M ³	PESO KG
30 M	300	600	12000	1200	2,262	5492
25 M	250	500	10000	1100	1,45	3552
20 M	250	350	9000	850	0,99	2419
16 M	250	300	8000	800	0,76	1862
12 M	200	250	7000	750	0,47	1151

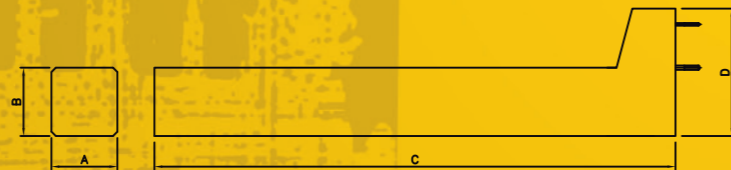

PILAR COM CABEÇA SIMPLES PARAFUSO						
VÃO	A (MM)	B (MM)	C (MM)	D (MM)	VOLUME M ³	PESO KG
30 M	300	600	12000	900	2,211	5512
25 M	250	500	10000	800	1,37	3356
20 M	250	350	9000	600	0,89	2174
16 M	250	300	8000	550	0,68	1666
12 M	200	250	7000	500	0,41	1004

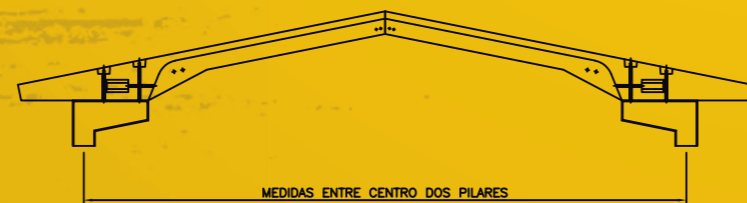

VIGAS E PILARES (FORMA REGULÁVEL SIMPLES E DUPLA)

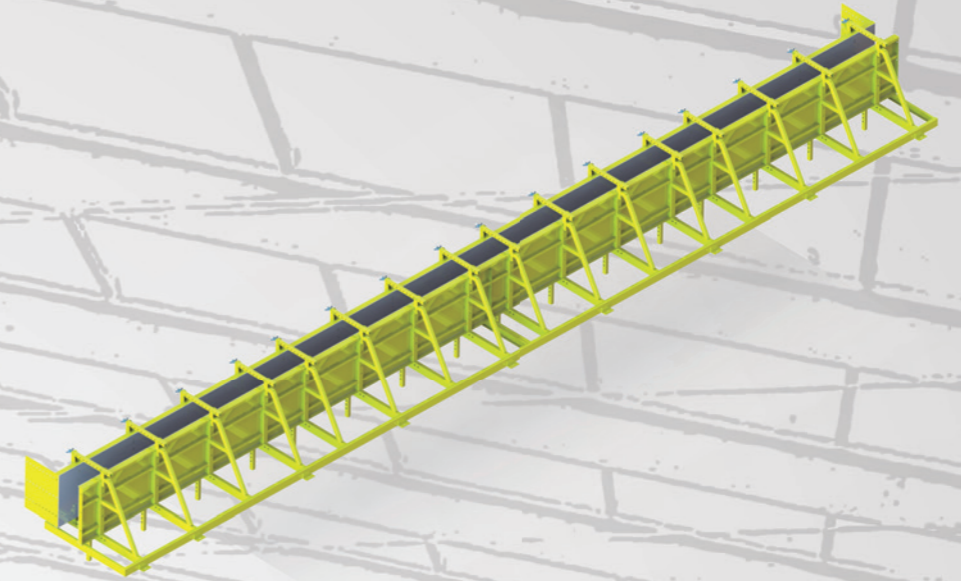

LAJE PI

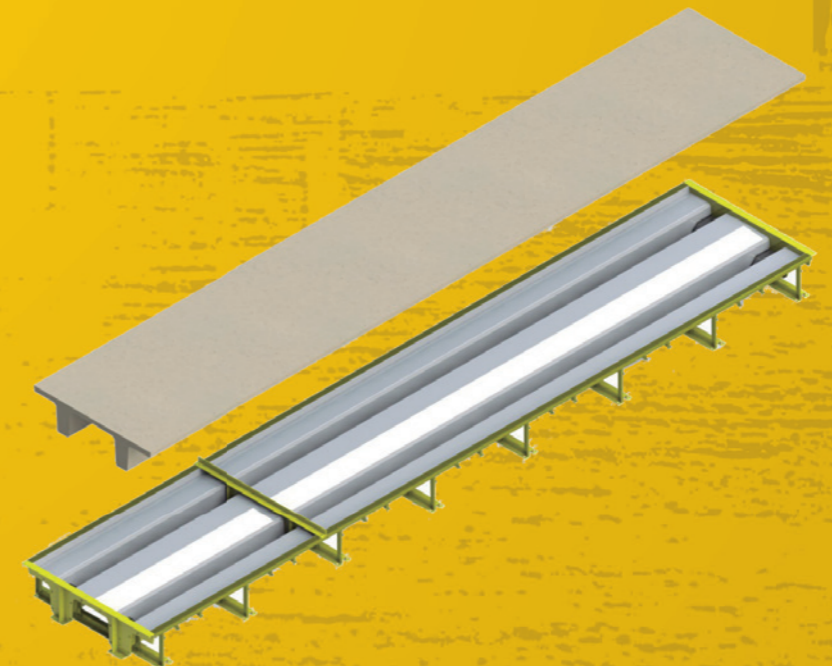

MOLDE DUPLO REGULÁVEL P/ PLACA DE FECHAMENTO

ESCADA

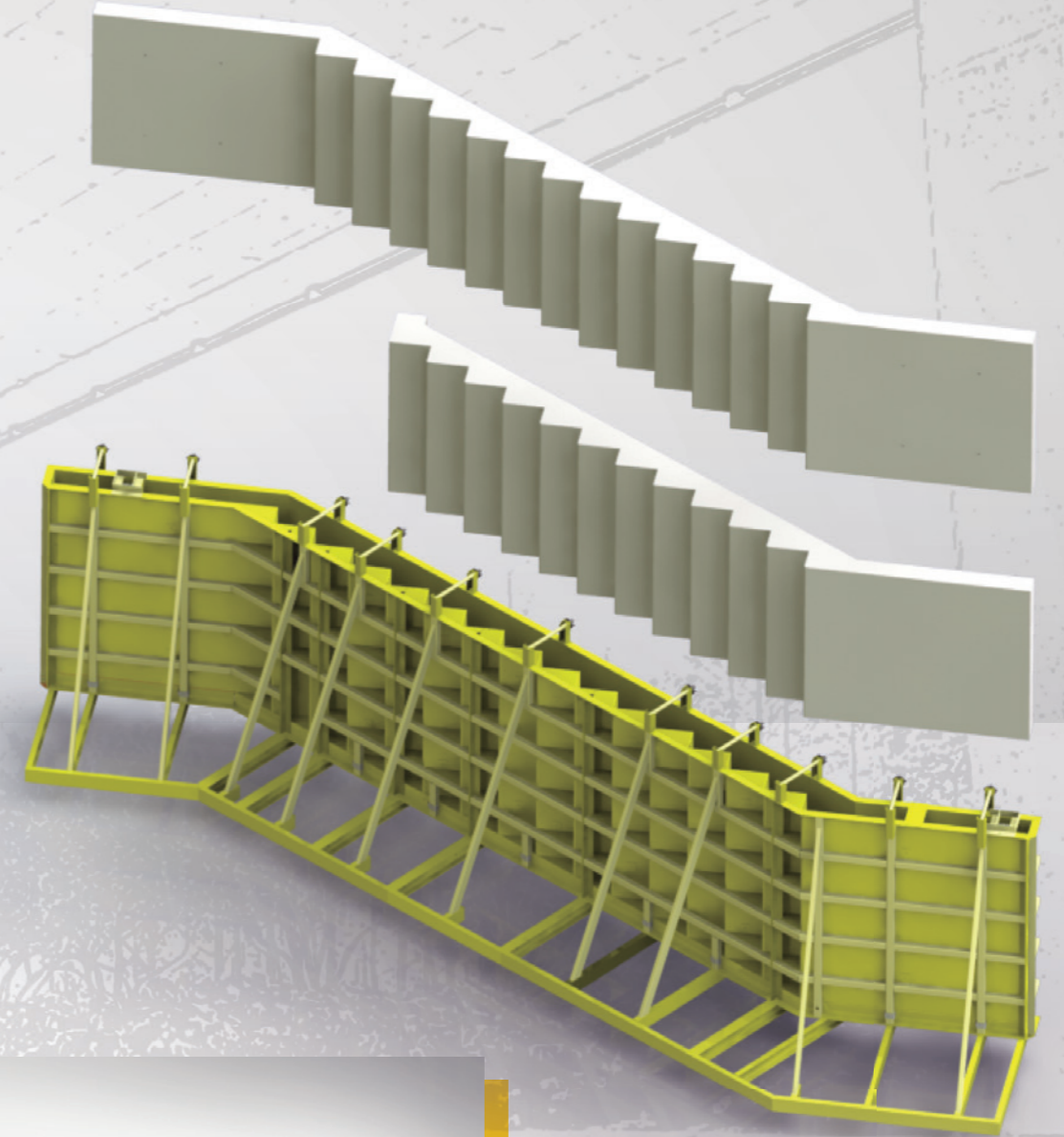



POSTE PADRÃO



TUBOS

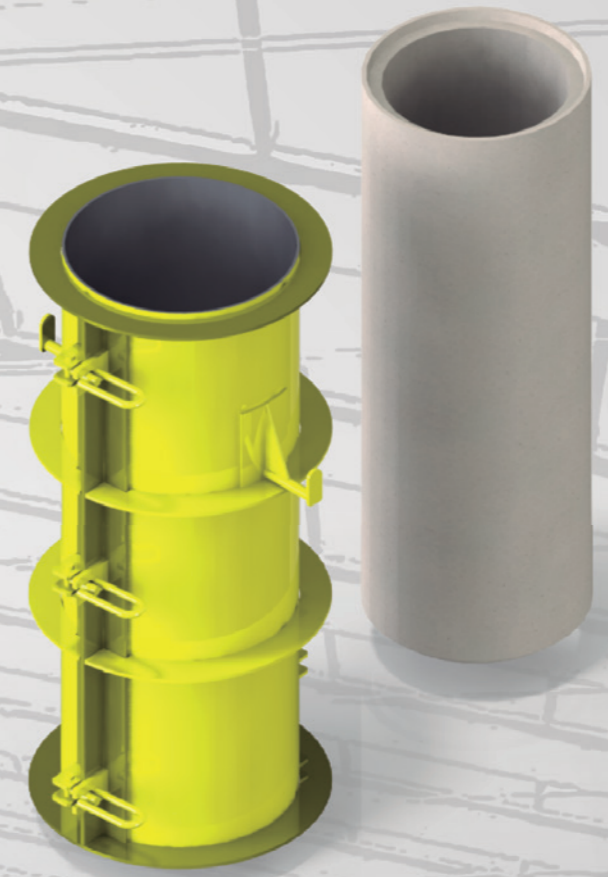

POSTE DT E CIRCULAR

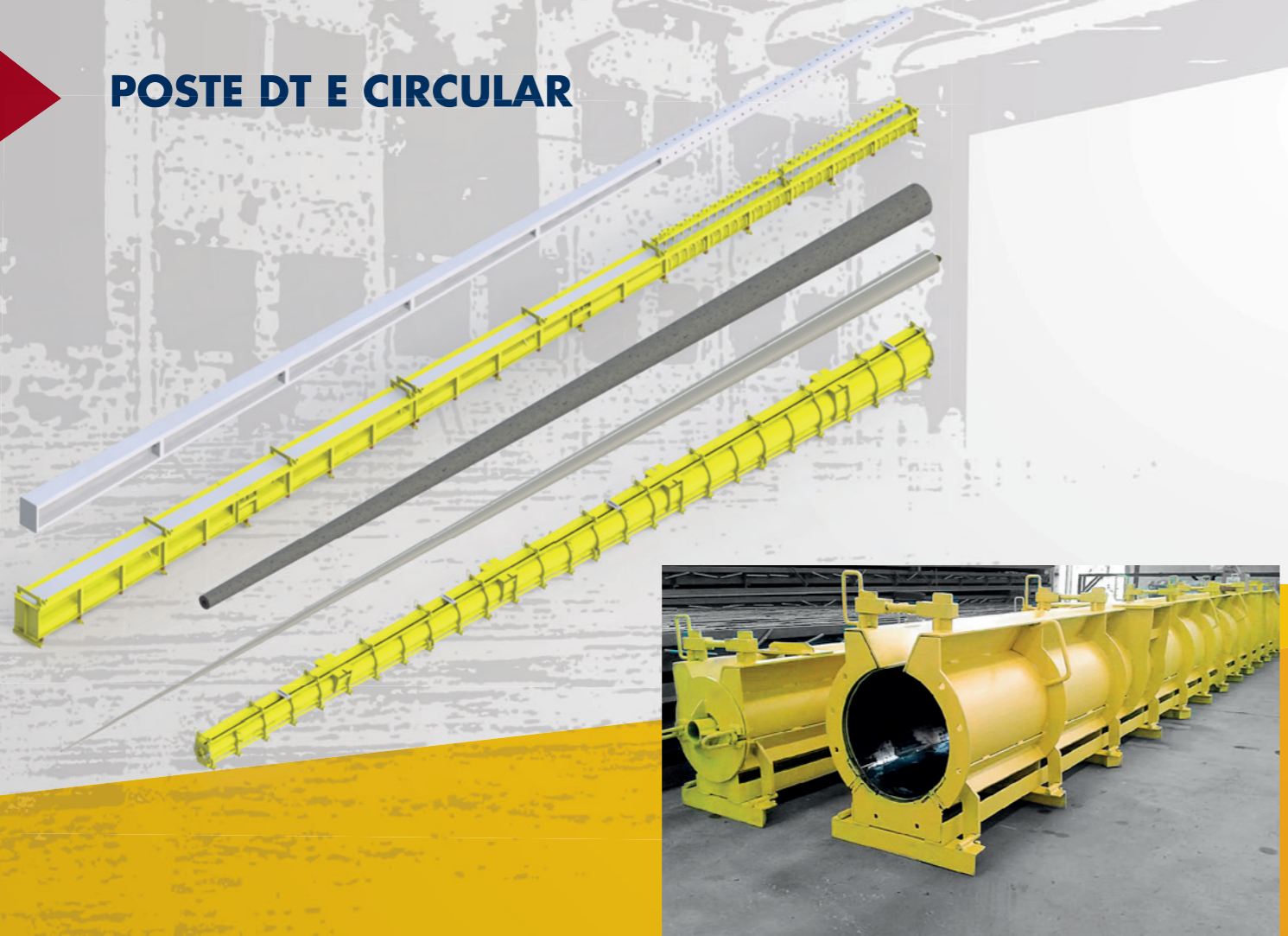

GALERIA

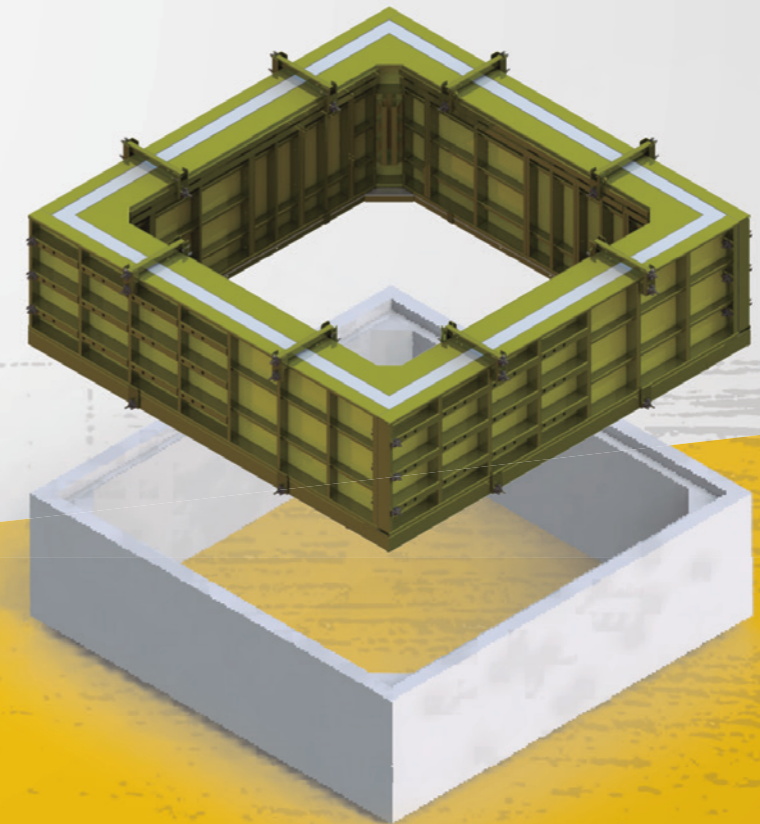



PÓRTICO



CENTRAL DE CONCRETO

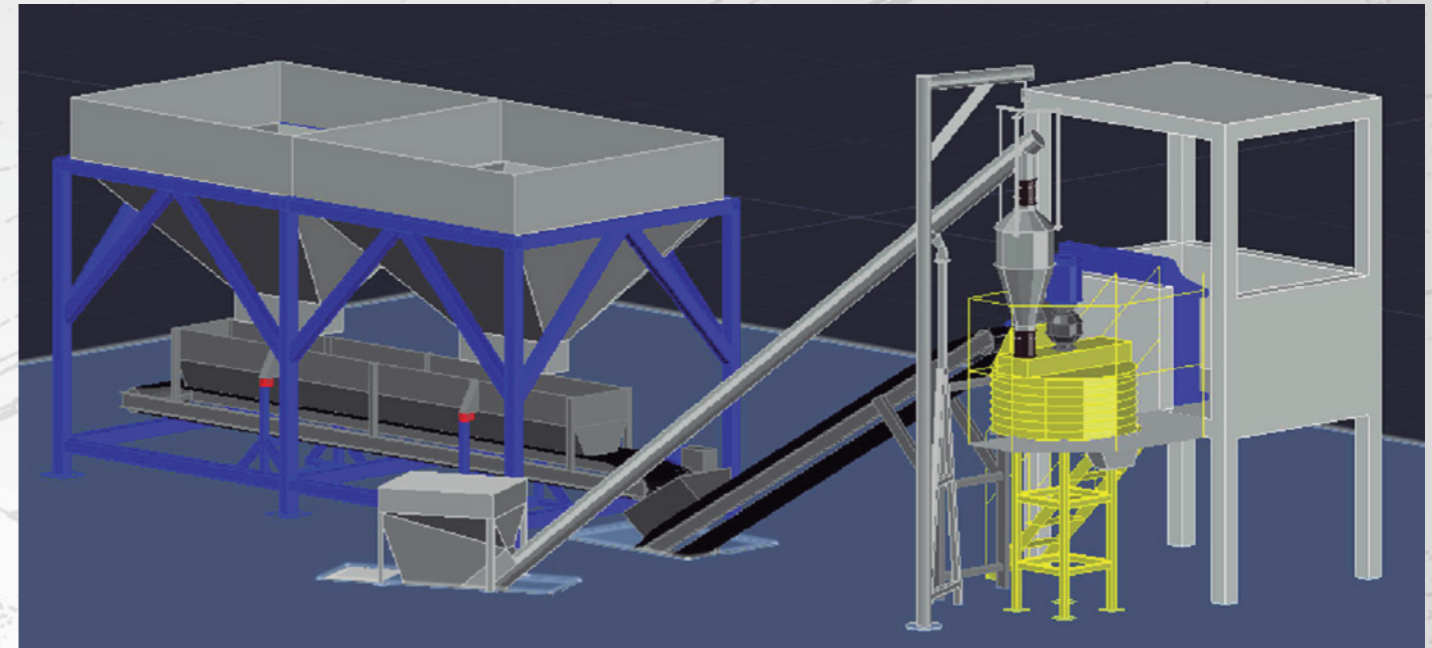

SILO ABASTECIMENTO AÉREO

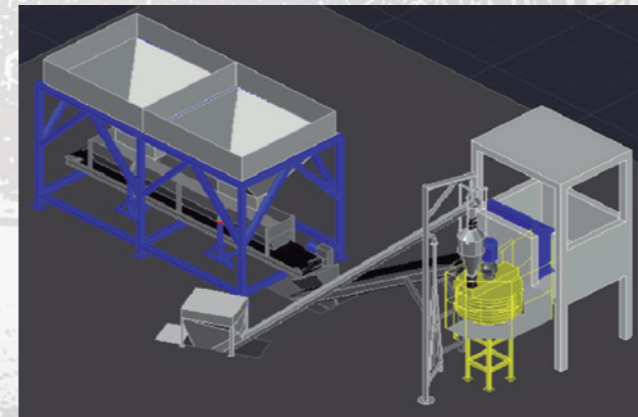

Vista Frontal

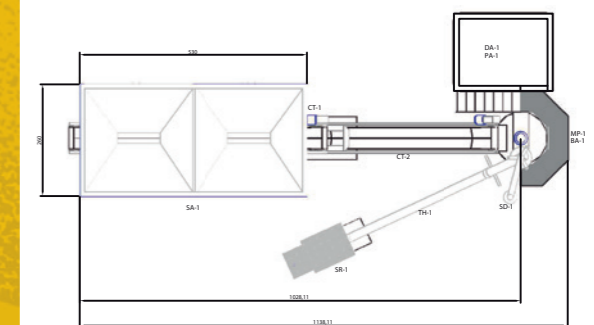

Planta Baixa





47 3375-3161

www.metlicaformas.com.br
vendas@metlicaformas.com.br

Rua Henrique Fuck, 405 - Corupá - SC